

KASK KL-1

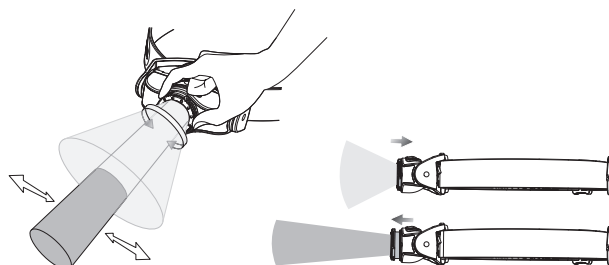

KASK KL-1

HELMET OVERHEAD BAND SET

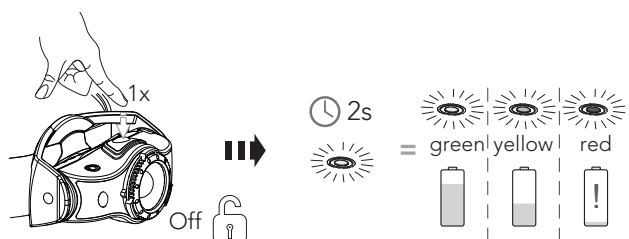
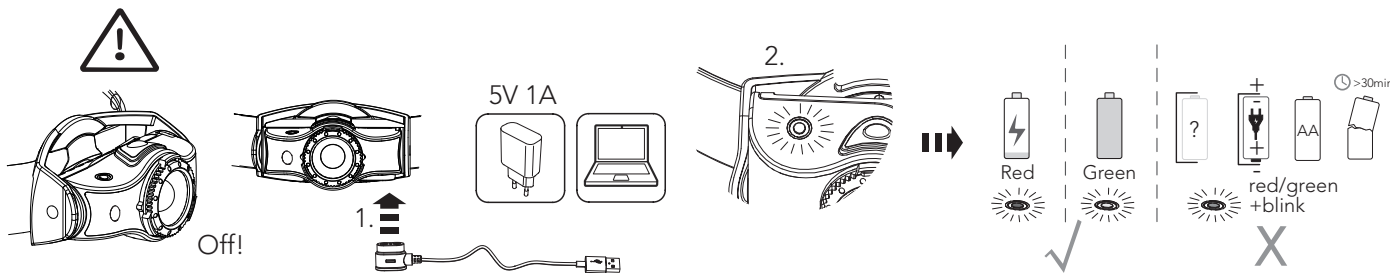
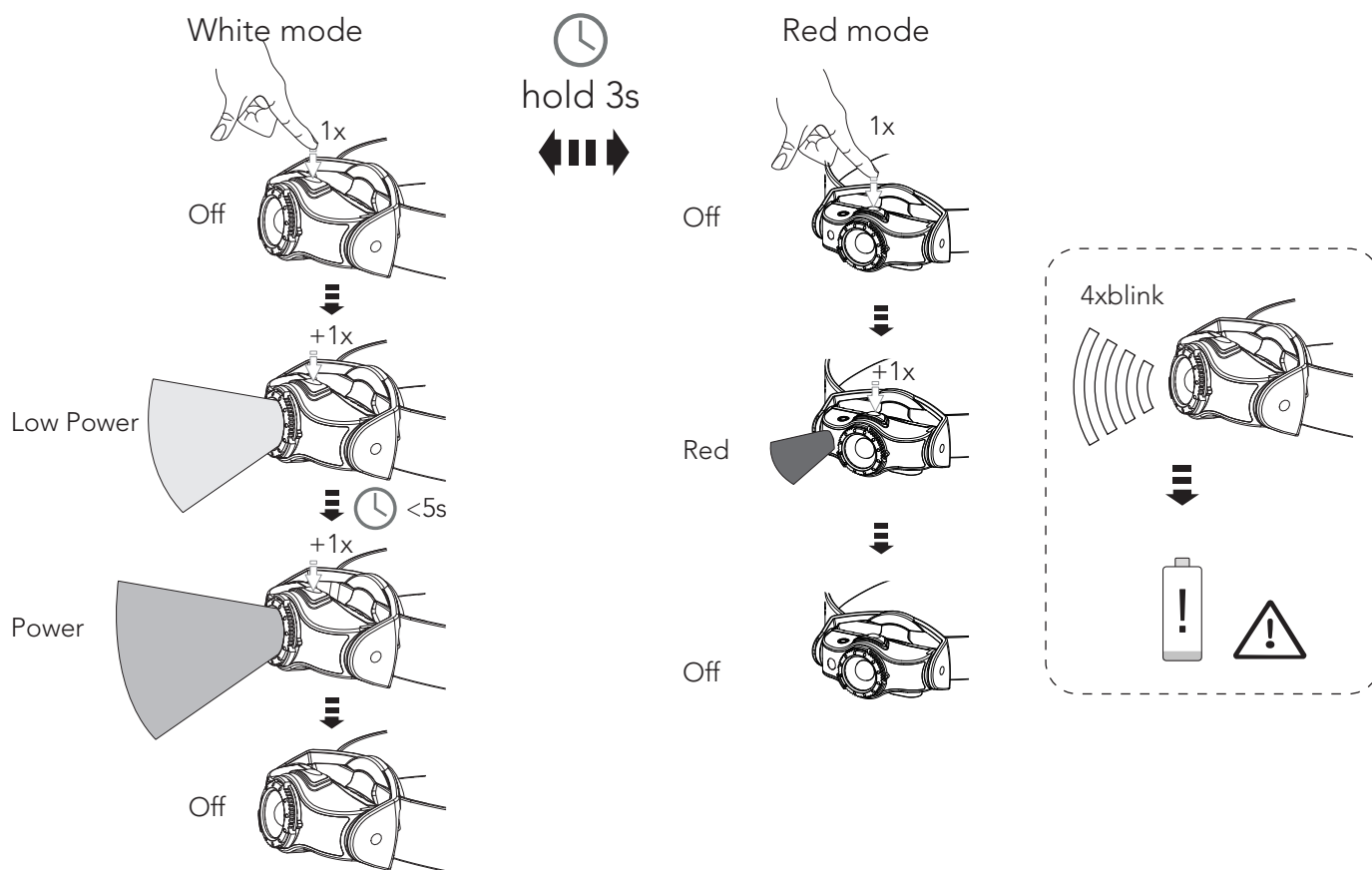
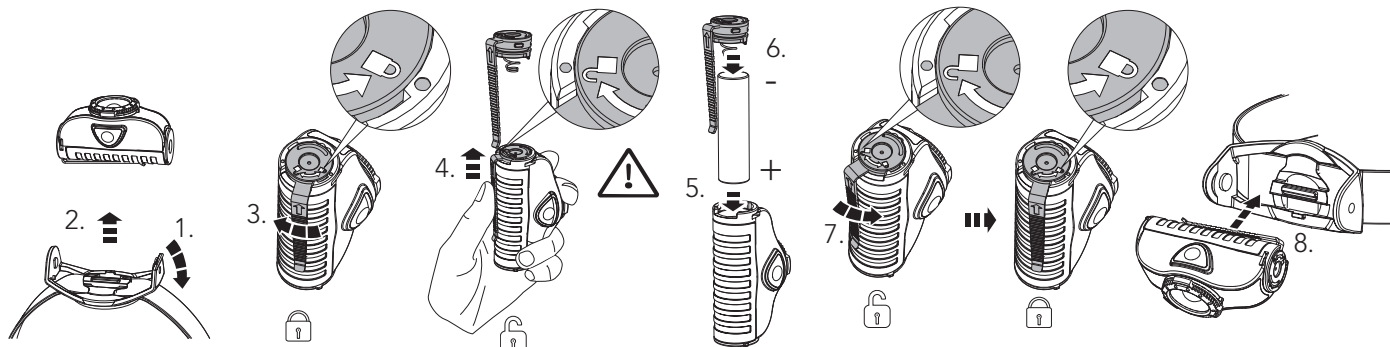
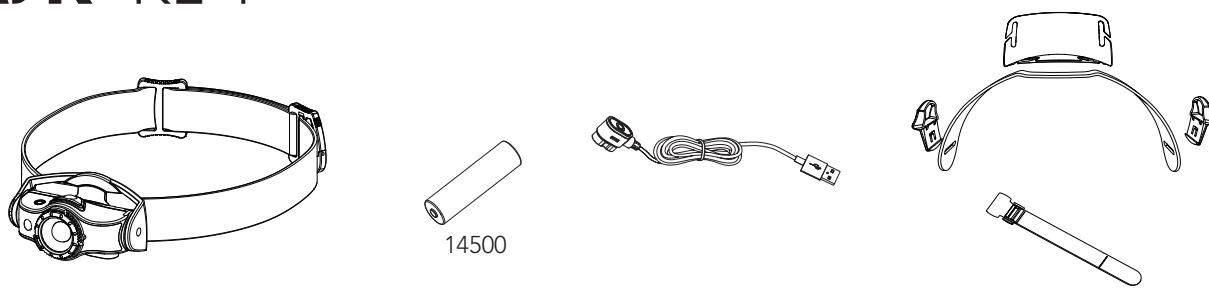
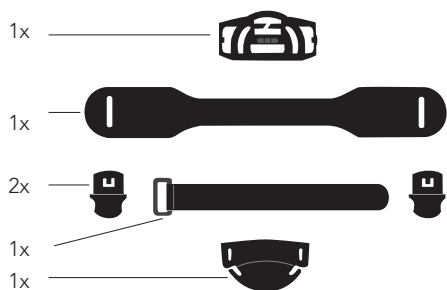

KL-1

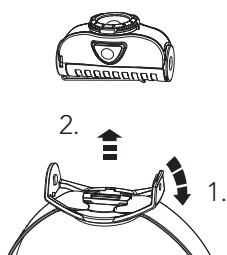

KL-2/KL-3

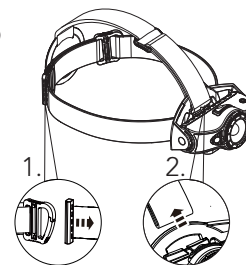

3.

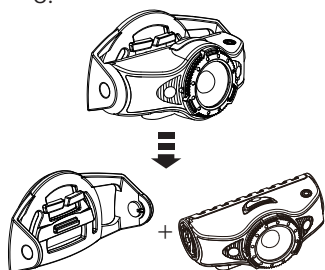

4.

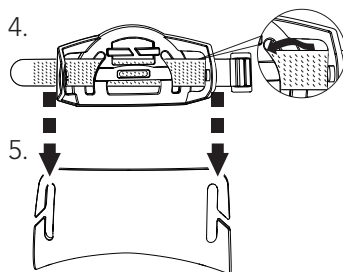

6.

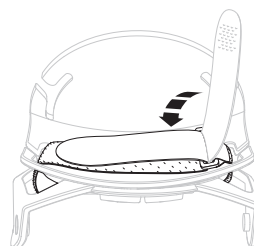

7.

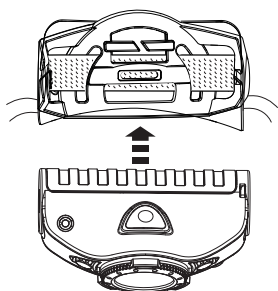

8.

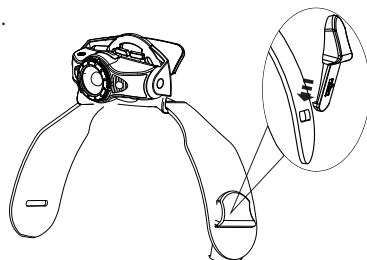

9.

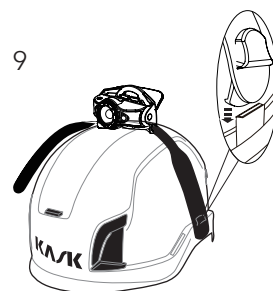

10.

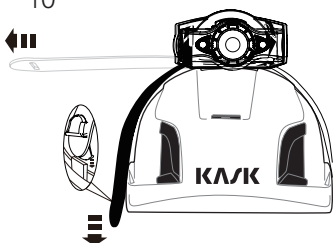

11.



12.

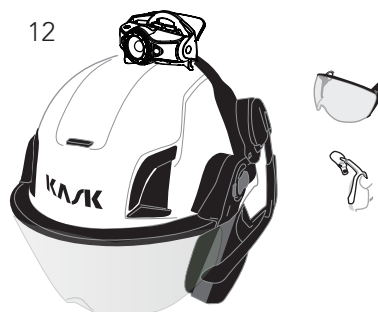

KASK S.p.A.

24060 Chiuduno, BG - Via Firenze, 5 - Italy

t. +39 035 4427497 - info@kask.com - www.kask.com

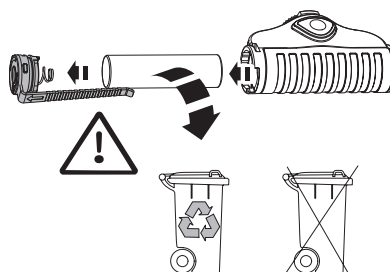
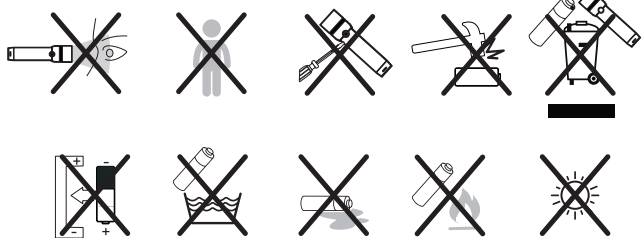

KL1_QUG_V0.1
 28.07.2020
 1J12A0411